

HeadWay LiFePO4 38120 Specifications

Drawing

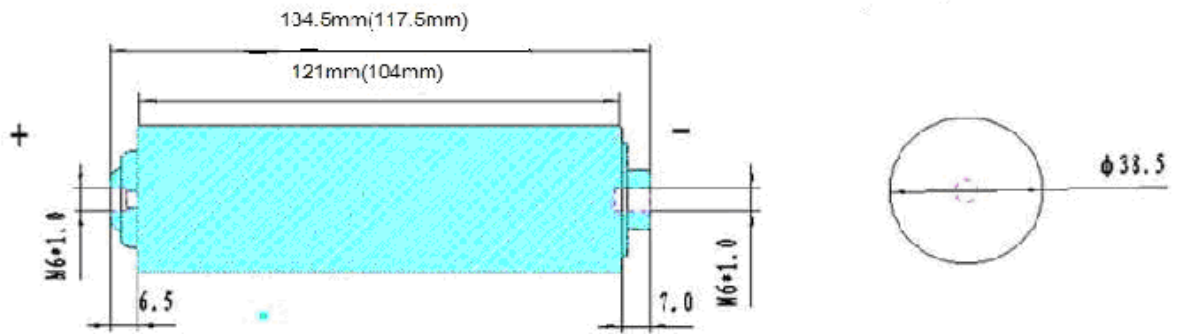

Technical comparing

1. traditional small cylindrical cell technical

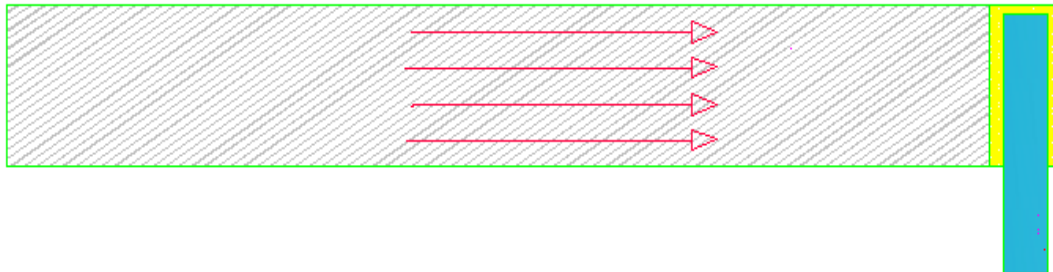

The current was collected lengthways

2. patent technic

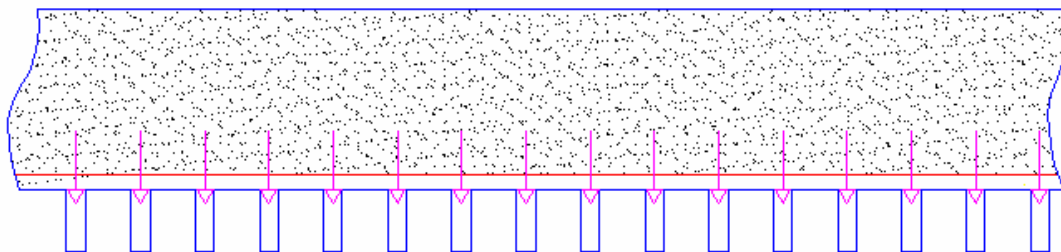

The current was collect lateral

General Specifications

Type	38120 (S/L)	38120P
Nominal capacity	10Ah	8Ah
Charging Voltage	3.65V	
Typical Voltage	3.2V	
Cut-off Discharge Voltage	2.0V	
Charging Method	CC/CV	
Maximum Discharge Current (continuable)	150A	200A
Maximum Charge Current (continuable)	60A	80A
Cycle Life	1500cycles 1C 100%DOD 2000cycles 1C 80%DOD	
Operation Temperature	Charge -10~45°C, Discharge -20~65°C	
Storage Temperature	-20~45°C	
Energy Density	105Wh/Kg	83 Wh/Kg
Power Density	850W/Kg	1200 W/Kg
Initial Internal Impedance	<6mΩ	<4mΩ

Performance Charts

38120S 10AH 1C Charge and Discharge Curve

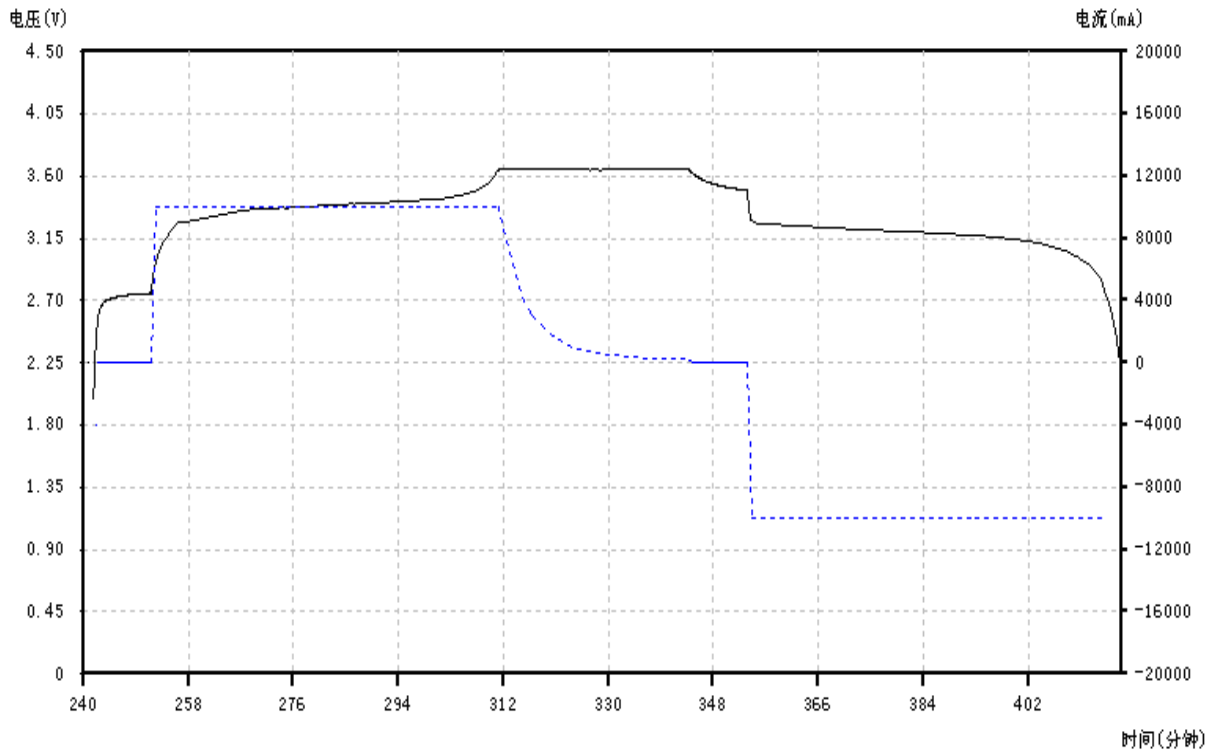

38120 cycle life curve (high temperature)

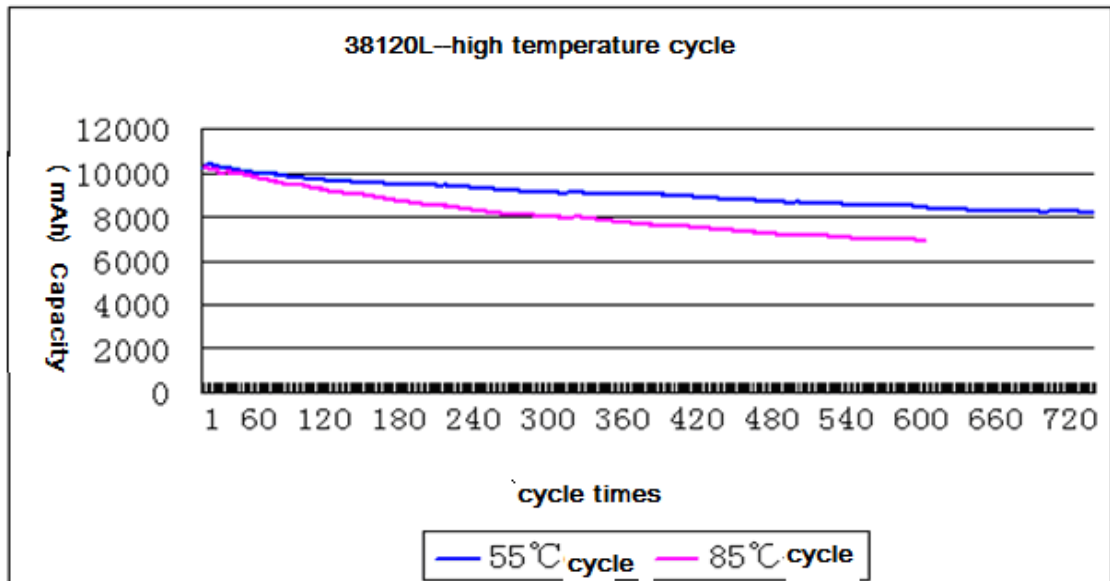

38120 cycle life curve (nominal temperature)

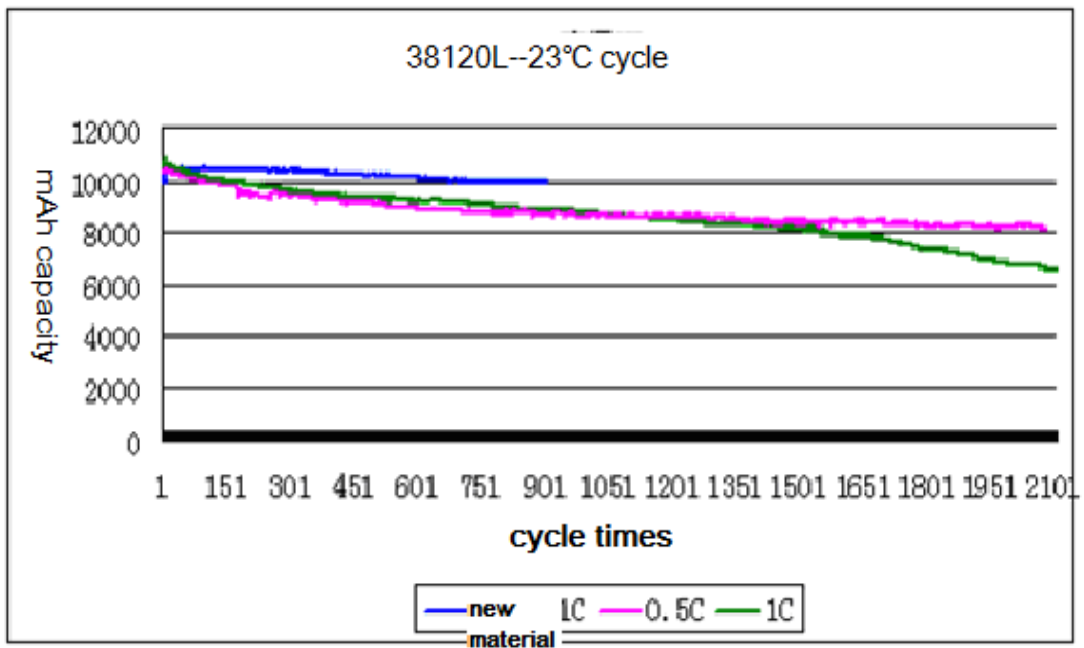

The superior function of ratio discharge (capacity)

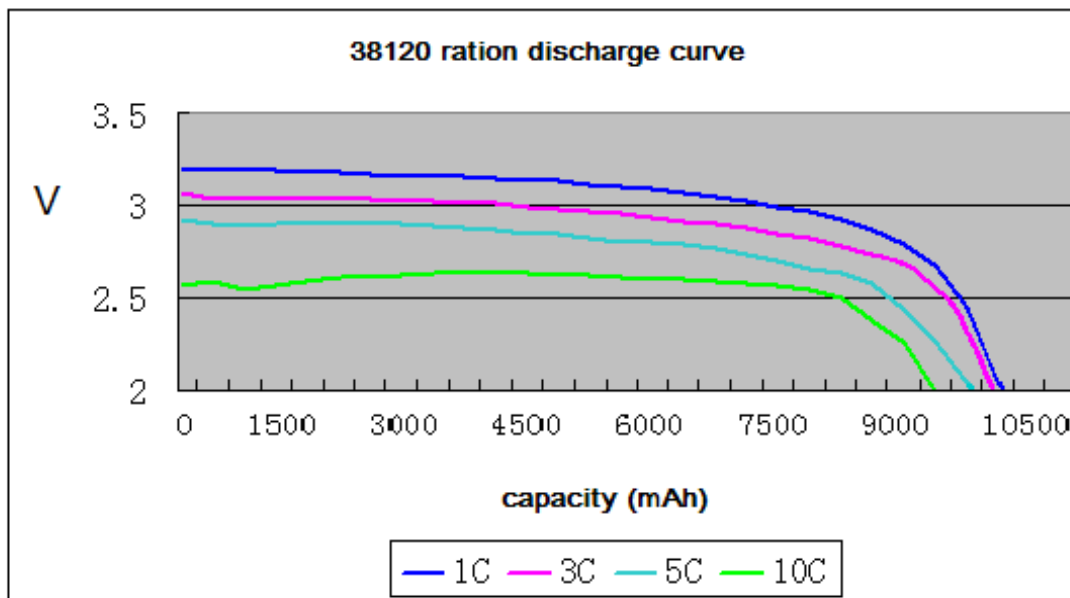

The superior function of ratio discharge (power)

